

Divider Blocks

Divider blocks are single line progressive hydraulic systems used to divide a single lubrication feed to multiple points while allowing each point to receive a different quantity of oil. They are heavy duty, precision, self-lubricating assemblies capable of pumping small amounts of oil either mineral or synthetic to machinery injection points at pressures up to 8000 psi.

Styles:

- XD Product Line
- HP Product Line

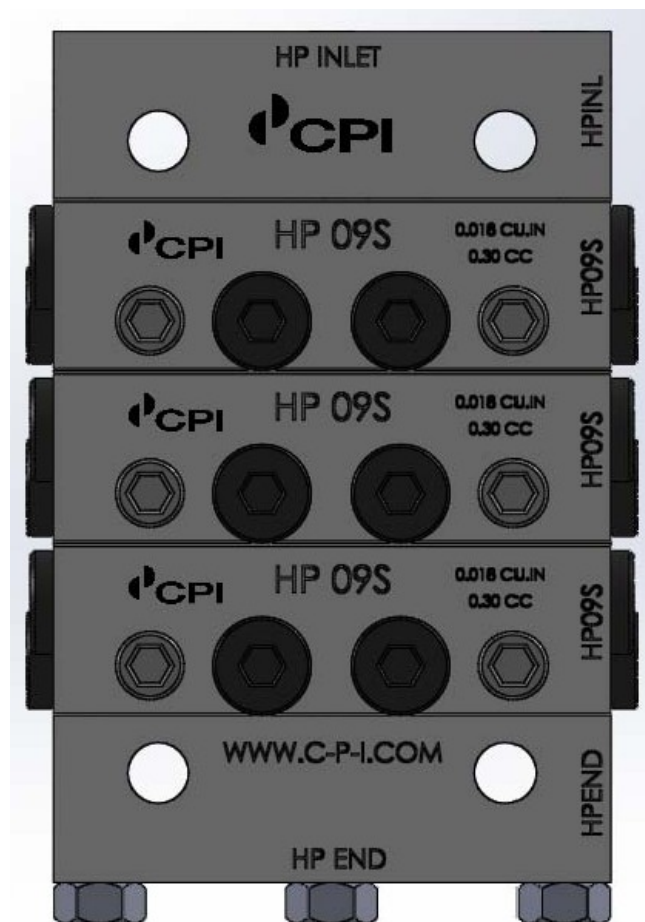

Index:

1. Warnings
2. Models
3. Specifications
4. Installation Instructions
5. Operation Instructions
6. Technical Information
7. Troubleshooting



1. Warnings

The following warnings are for the setup, use, grounding, maintenance, and repair of this equipment. The exclamation point symbol alerts you to a general warning and the hazard symbols refer to procedures-specific risks. When these symbols appear in the body of this manual, refer back to these Warnings. Product-specific hazard symbols and warnings not covered in this section may appear throughout the body of this manual where applicable.

 Warning	
	<p>SKIN INJECTION HAZARD</p> <p>High-pressure fluid from dispensing device, hose leaks, or ruptured components will pierce skin. This may look like just a cut, but it is a serious injury that can result in amputation. Get immediate surgical treatment.</p> <ul style="list-style-type: none">• Do not point dispensing device at anyone or at any part of the body.• Do not put your hand over the fluid outlet.• Do not stop or deflect leaks with your hands, body, glove, or rag.• Relieve the pressure in the lines before cleaning, checking, or servicing equipment.• Tighten all fluid connections before operating the equipment.• Check hoses and couplings regularly. Replace worn or damaged parts immediately.
	<p>FIRE AND EXPLOSION HAZARD</p> <p>When flammable fluids are present in the work area, such as gasoline, be aware that flammable fumes can ignite or explode. To help prevent fire and explosion:</p> <ul style="list-style-type: none">• Use equipment only in well ventilated area.• Eliminate all ignition sources, such as cigarettes and portable electric lamps.• Keep work area free of debris, including rags and spilled or open containers of solvent and gasoline.• Do not plug or unplug power cord or turn lights on or off when flammable fumes are present.• Ground all equipment in the work area.• Use only grounded hoses.• Stop operation immediately if static sparking occurs or you feel a shock. Do not use equipment until you identify and correct the problem.• Keep a working fire extinguisher in the work area.

Warning



EQUIPMENT MISUSE HAZARD

Misuse can cause death or serious injury.

- Do not operate the unit when fatigued or under the influence of drugs or alcohol.
- Do not exceed the maximum working pressure or temperature rating of the lowest rated system component. See **Technical Data** in all equipment manuals.
- Use fluids and solvents that are compatible with equipment wetted parts. See Technical Data in all equipment manuals. Read fluid and solvent manufacturer's warnings. For complete information about your material, request MSDS from distributor or retailer.
- Turn off all equipment when equipment is not in use.
- Repair or replace worn or damaged parts immediately with genuine manufacturer's replacement parts only.
- Do not alter or modify equipment. Alterations or modifications may void agency approvals and create safety hazards.
- Make sure all equipment is rated and approved for the environment in which you are using it.
- Use equipment only for its intended purpose. Call CPI for clarification if needed.
- Route hose and cables away from traffic areas, sharp edges, moving parts, and hot surfaces.
- Do not kink or over bend hoses or use hoses to pull equipment.
- Keep children and animals away from work area.
- Comply with all applicable safety regulations.



PERSONAL PROTECTIVE EQUIPMENT

Wear appropriate protective equipment when in the work area to help prevent serious injury, including eye injury, hearing loss, inhalation of toxic fumes, and burns. This protective equipment includes but is not limited to:

- Protective eye wear, and hearing protection.
- Respirators, protective clothing, and gloves as recommended by the fluid and solvent manufacturer.

2. Models

CPI XD Divider Block Components		
Full Part #	Part #	Description
<u>XD METERING ELEMENTS</u>		
6500300000XD06S	XD06S	XD 06S METERING ELEMENT
6500300000XD06T	XD06T	XD 06T METERING ELEMENT
6500300000XD09S	XD09S	XD 09S METERING ELEMENT
6500300000XD09T	XD09T	XD 09T METERING ELEMENT
6500300000XD12S	XD12S	XD 12S METERING ELEMENT
6500300000XD12T	XD12T	XD 12T METERING ELEMENT
6500300000XD15S	XD15S	XD 15S METERING ELEMENT
6500300000XD15T	XD15T	XD 15T METERING ELEMENT
6500300000XD18S	XD18S	XD 18S METERING ELEMENT
6500300000XD18T	XD18T	XD 18T METERING ELEMENT
6500300000XD21S	XD21S	XD 21S METERING ELEMENT
6500300000XD21T	XD21T	XD 21T METERING ELEMENT
6500300000XD24S	XD24S	XD 24S METERING ELEMENT
6500300000XD24T	XD24T	XD 24T METERING ELEMENT
6500300000XD30S	XD30S	XD 30S METERING ELEMENT
6500300000XD30T	XD30T	XD 30T METERING ELEMENT
<u>XD CROSSPORT BARS</u>		
6500300000XDCPL	XDCPL	XD CROSSPORT BAR LEFT
<u>XD BASE PLATE ASSEMBLIES</u>		
6500300000XDBP3	XDBP3	XD 3 SECTION BASE PLATE
6500300000XDBP4	XDBP4	XD 4 SECTION BASE PLATE
6500300000XDBP5	XDBP5	XD 5 SECTION BASE PLATE
6500300000XDBP6	XDBP6	XD 6 SECTION BASE PLATE
<u>XD BASE COMPONENTS</u>		
6500300000XDINL	XDINL	XD INLET BASE
6500300000XDIMD	XDIMD	XD INTERMEDIATE BASE
6500300000XDEND	XDEND	XD END BASE
<u>XD TIE RODS</u>		
6500300000XDTR03	XDTR03	XD TIE ROD 3 SECTION
6500300000XDTR04	XDTR04	XD TIE ROD 4 SECTION
6500300000XDTR05	XDTR05	XD TIE ROD 5 SECTION
6500300000XDTR06	XDTR06	XD TIE ROD 6 SECTION
<u>XD & HP FITTINGS AND PLUGS</u>		
65003001827PLUG	1827PLUG	1/8-27 ORB PLUG
65003071620PLUG	71620PLUG	7/16-20 ORB PLUG
65003014NPTPLUG	14NPTPLUG	1/4-18 NPT PLUG, RECESSED HEX
65002000421PROR	421PROR	INTEGRAL BASE CHECK VALVE & TUBE FITTING, 1/8-27 ORB
6500300000TRNUT	TRNUT	TIE ROD NUT

CPI HP Divider Block Components		
Full Part #	Part #	Description
<u>HP METERING ELEMENTS</u>		
6500300000HP06S	HP06S	HP 06S METERING ELEMENT
6500300000HP06T	HP06T	HP 06T METERING ELEMENT
6500300000HP09S	HP09S	HP 09S METERING ELEMENT
6500300000HP09T	HP09T	HP 09T METERING ELEMENT
6500300000HP12S	HP12S	HP 12S METERING ELEMENT
6500300000HP12T	HP12T	HP 12T METERING ELEMENT
6500300000HP15S	HP15S	HP 15S METERING ELEMENT
6500300000HP15T	HP15T	HP 15T METERING ELEMENT
6500300000HP18S	HP18S	HP 18S METERING ELEMENT
6500300000HP18T	HP18T	HP 18T METERING ELEMENT
6500300000HP21S	HP21S	HP 21S METERING ELEMENT
6500300000HP21T	HP21T	HP 21T METERING ELEMENT
6500300000HP24S	HP24S	HP 24S METERING ELEMENT
6500300000HP24T	HP24T	HP 24T METERING ELEMENT
6500300000HP30S	HP30S	HP 30S METERING ELEMENT
6500300000HP30T	HP30T	HP 30T METERING ELEMENT
<u>HP CROSSPORT BAR</u>		
6500300000HPCPL	HPCPL	HP CROSSPORT BAR LEFT
6500300000HPCPR	HPCPR	HP CROSSPORT BAR RIGHT
6500300000HPCPB	HPCPB	HP CROSSPORT BAR BOTH
<u>HP BASE PLATE ASSEMBLIES</u>		
6500300000HPBP3	HPBP3	HP 3 SECTION BASE PLATE
6500300000HPBP4	HPBP4	HP 4 SECTION BASE PLATE
6500300000HPBP5	HPBP5	HP 5 SECTION BASE PLATE
6500300000HPBP6	HPBP6	HP 6 SECTION BASE PLATE
6500300000HPBP7	HPBP7	HP 7 SECTION BASE PLATE
<u>HP BASE COMPONENTS</u>		
6500300000HPINL	HPINL	HP INLET BASE
6500300000HPIMD	HPIMD	HP INTERMEDIATE BASE
6500300000HPEND	HPEND	HP END BASE
<u>HP TIE RODS</u>		
6500300000HPTR03	HPTR03	HP TIE ROD 3 SECTION
6500300000HPTR04	HPTR04	HP TIE ROD 4 SECTION
6500300000HPTR05	HPTR05	HP TIE ROD 5 SECTION
6500300000HPTR06	HPTR06	HP TIE ROD 6 SECTION
6500300000HPTR07	HPTR07	HP TIE ROD 7 SECTION

3. Specifications

XD Max Working Pressure _____ 8000 psi
 HP Max Working Pressure _____ 6000 psi
 Dropsa SMX Max Working Pressure _____ 4000 psi
 Max Oil Viscosity _____ 8000 SUS (1700 CPS)
 Min Oil Viscosity _____ 80 SUS (15 CPS)

**Suitable for Use with Petroleum and Synthetic Base Lubricants*

Divider Block Element Outputs		
HP/ XD Element Size	Description	Volume per Output in in³
06T	0.006 twin	0.006
06S	0.006 single	0.012
09T	0.009 twin	0.009
09S	0.009 single	0.018
12T	0.012 twin	0.012
12S	0.012 single	0.024
15T	0.015 twin	0.015
15S	0.015 single	0.030
18T	0.018 twin	0.018
18S	0.018 single	0.036
21T	0.021 twin	0.021
21S	0.021 single	0.042
24T	0.024 twin	0.024
24S	0.024 single	0.048
30T	0.030 twin	0.030
30S	0.030 single	0.060

Fluid Measurement Conversion Data		
(NOTE: All measurements are approximate values only)		
Number of Drops	US Measurement	Metric Measurement
1 drop	0.002 cubic inch	0.033 cubic centimeter (cc)
30 drops	0.061 cubic inch	1 cubic centimeter (cc)
500 drops	1 cubic inch	16.39 cubic centimeter (cc)
14,500 drops	1 pint	0.47 Liter
10 drops/minute	1 pint/24 hours	0.47 Liter /24 hours
		1 (cc) = 1 mL

4. Installation

4.1 Mounting Divider Blocks

Install the master divider block (the first divider block downstream of the pump) as close to the pump as possible. This will allow the operator to adjust the lubricator pump while monitoring cycle time of the system to achieve correct lubrication rates.

Install secondary divider blocks as close as possible to the injection points on the compressor cylinders and rod packing. This procedure eliminates long tubing runs from the divider block to the injection points and enables the operator to easily inspect the system for tubing leaks.

- Mount all divider blocks parallel to the floor. This allows complete purging of air from the system and makes it easier to install straight and plumb tubing runs. (See Fig.1)
- Avoid installing the divider blocks in locations that prevent easy access for preventative maintenance or replacement.
- The indicator port plugs on the front of the divider blocks should be easily accessed for troubleshooting the system for blockage and for ease of replacement.
- The divider blocks may be mounted directly to the compressor frame, if the surface can be drilled and tapped. When mounting the divider blocks directly to the cylinder. **DO NOT** use long drill bits that can penetrate through the inside wall of the compressor cylinder or frame.
- Mount all divider blocks on a flat surface whenever possible. Mounting to an uneven surface may cause distortion in the piston bores and create premature wear or failure.
- Use properly sized bolts for mounting the divider blocks to the compressor frame.
- Use divider block mounting brackets in areas that require the divider block to be raised from the mounting surface to enable reliable tubing installation. CPI has several styles of mounting brackets to ensure correct mounting of the divider blocks.

CAUTION: When using a mounting plate that must be welded in place **NEVER** weld on a mounting place with the divider block installed or with any electronic equipment connected to the skid or compressor (no-flow shutdown devices included). Heat or sparking generated during welding will permanently damage the divider blocks and any electronic equipment connected.

- Install all divider block assemblies in an area on

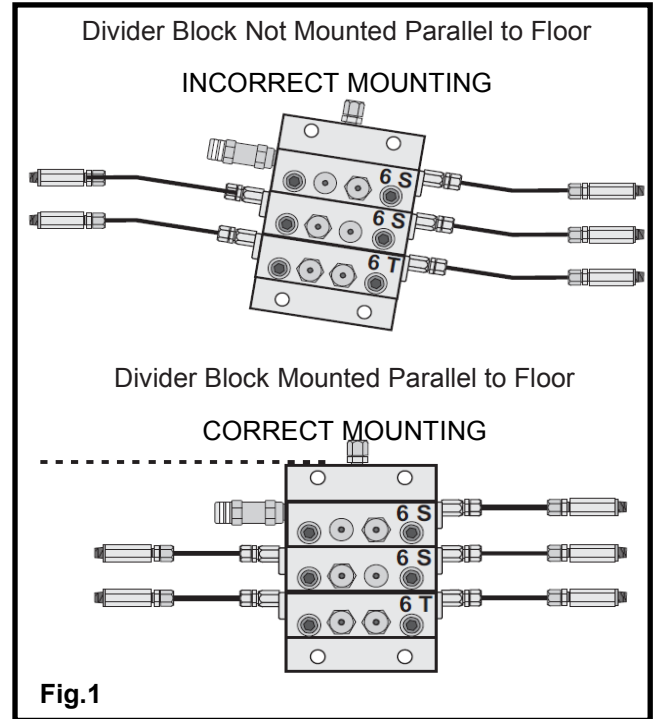

Fig.1

the compressor to avoid damage from debris or dropped objects.

- Install the tubing on the compressor frame away from common areas that must be accessed for maintenance and out of areas commonly used for stepping or where there is the possibility of damage from debris or dropped objects.
- Keep all multiple tubing runs from secondary divider blocks as short as possible to reduce the total lubricant volume held in the lines to the injection points.

4.2 Grounding

The equipment must be grounded to reduce the risk of static sparking. Static sparking can cause fumes to ignite or explode. Grounding provides an escape wire for the electric current.						

Ensure the Divider Block is properly grounded.

4.3 Filtration

We recommend installing a 10 micron high pressure filter prior to the inlet of the divider block to filter out any debris that may be in the oil.

5. Operation

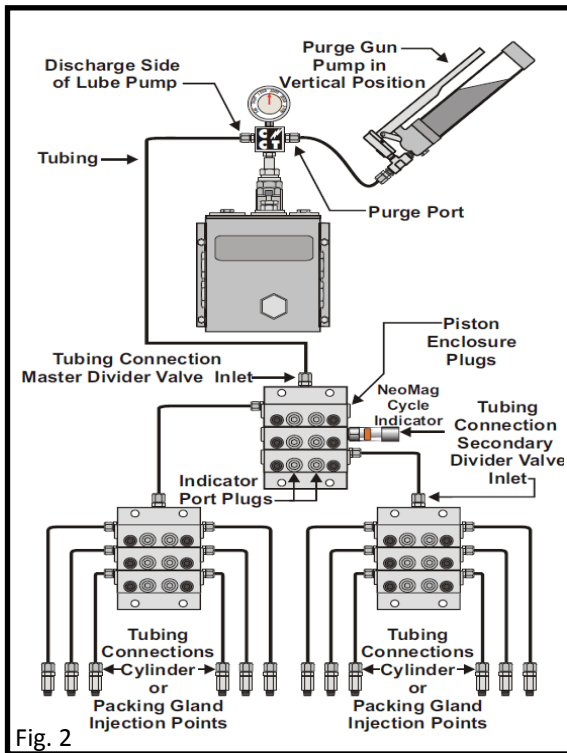

5.1 Purging Air From the System

1. Once the system is installed the first step is to fully prime the system with fresh oil and then purge all air from the system.
2. Ensure that the main oil supply is connected and then begin the process of purging the complete system of air, including the divider block.
3. After maintenance or before compressor start-up loosen the tubing connections at the inlet of the master divider block, cylinder and packing gland injection points. If there are secondary divider blocks, loosen tubing connections at the inlet of the secondary divider blocks.
4. If a purge port is available at the pump head connect the purge gun (see fig. 2). If no purge port is available, remove the tubing from the discharge side of the pump and connect the purge gun to the tubing.
5. Pump clean oil common to the system into the tubing line until there are no air bubbles observed flowing from the tubing connection at the inlet of the master divider block. Always hold purge gun in a vertical position to eliminate pumping air into the system.
6. Tighten the tubing connection at the inlet of the master divider block while oil is still flowing.

7. Continue to operate the purge gun until no air bubbles are observed flowing from the tubing connection at the inlet of the secondary divider block.
8. Tighten the tubing connection at the inlet of the secondary divider block while oil is still flowing.
9. Continue to operate the purge gun until no air bubbles are observed flowing from the tubing connections at the cylinder or packing gland injection points.
10. Tighten the tubing connections at the cylinder and packing gland injection points while oil is still flowing.

5.2 Checking Divider Block Operation

Once this process is complete the system can be tested. If the system is crank driven the compressor needs to be started and the lube rate set to the desired cycle time. To do this the feed pump will have to be adjusted, please see the pump adjustment process in the pump operation manual.

Divider block system lube rates are provided in the form of a cycle time. This is the amount of time required for the complete divider block assembly to complete one full cycle, an injection of oil at every point on the master block. In order to set this rate a cycle indicator must be installed, either digital or visual. The cycle time must be observed and the pump adjusted accordingly until the design or break in cycle time is achieved.

5.3 Pressure Relief Procedure

<p>This equipment stays pressurized until pressure is manually relieved. To help prevent serious injury from pressurized fluid, such as skin injection, splashing fluid and moving parts, follow the Pressure Relief Procedure below when you stop pumping and before cleaning, checking or servicing the equipment.</p>					

1. Stop lube pump.
2. If installed, close oil supply valve located upstream from pump.
3. If installed, open drain valve located downstream from pump.
4. Slowly crack open fluid line fittings to relieve pressure from system

6. Technical Info

6.1 Calculating Output Capacity

The following calculations are in imperial units, to use them all data must be converted before running any calculations.

To determine the cycle time of the Divider Block you must time the visual cycle indicator from the start position until it returns to the same position. If you are timing using an LED on Digital No-Flow Timer, the time between blinks of the LED is the cycle time. Any type of a visual cycle indicator, or a blinking LED will provide means for determining the quantity of oil flowing through the lubrication system by the following formula:

Q = Flow Rate in Pints Per Day

M = Total Value of the Divider Block Elements

6 = The constant resulting from converting cubic inches to pints and seconds to days

T = Time in seconds for one complete cycle of the Divider Block. Note: Cycle indicator pin must travel from full out position and return to full out to indicate one full cycle. Each blink of the LED on the Digital No-Flow Timer indicates one full cycle of the Divider Block.

$$Q = \frac{6M}{T}$$

Examples:

Example 1: Cycle time of the Divider Block is 22 seconds. To find the quantity of oil currently flowing through the Divider Block in pints per day:

(24 hours operation at current RPM)

1. Add the total of the numbers on the front of the individual Divider Blocks Elements.

Example: (24+12+24 =60)

2. Multiply the total value of the Divider Block Elements x 6.

Example: (6x60=360)

3. Divide the answer (360) by the cycle time in seconds.

Example:

(360 / 22=16.36 Pints Per Day Total to Compressor)

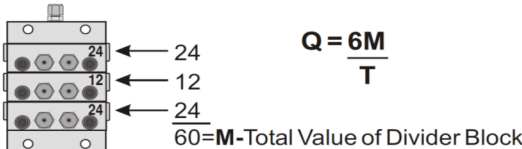

$$Q = \frac{6M}{T}$$

$$M = 60 \times 6 = 360$$

$$T = 22$$

$$Q = 16.36 \text{ Pints Per Day Total Pump Rate}$$

Example 2: If the flow rate is incorrect and the recommended oil consumption in Pints Per Day is known, use the following formula to adjust the lubricator pump for correct cycle time.

Recommended oil consumption is 16.36 Pints Per Day.

1. Add the total of the numbers on the front of the individual divider blocks. Example: (24+12+24 =60)
2. Multiply the total value of the Divider Block Elements x 6. Example: (6x60=360)
3. Divide the answer (360) by the lube rate in pints per day. Example: (360/16=22 second cycle time)

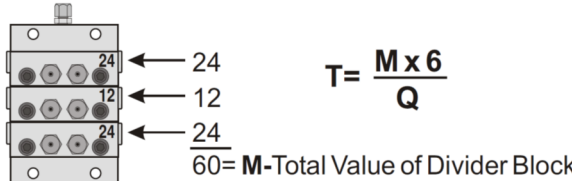

$$T = \frac{M \times 6}{Q}$$

$$M = 60 \times 6 = 360$$

$$Q = 16.36$$

$$T = 22 \text{ Cycle Time In Seconds}$$

6.2 Adjusting Rates to Suit Alternate Compressor RPM

To determine correct cycle time for compressors running at reduced RPM: Multiply the recommended cycle time of the Divider Block by the rated RPM of the compressor and divide by the actual RPM of the compressor.

Example 3:

Recommended cycle time = 22 seconds

Rated or Design RPM = 1200

Actual RPM = 1000

$$\frac{22 \times 1200}{1000} = 26 \text{ second cycle time}$$

6.3 XD Divider Block Dimensions

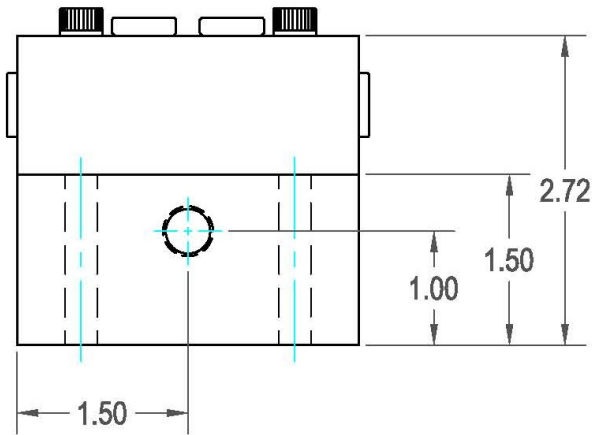

XD Sections	A ±
	0.010" [0.254mm]
3	4.690" [119.13mm]
4	5.940" [150.88mm]
5	7.190" [182.63mm]
6	8.440" [214.38mm]

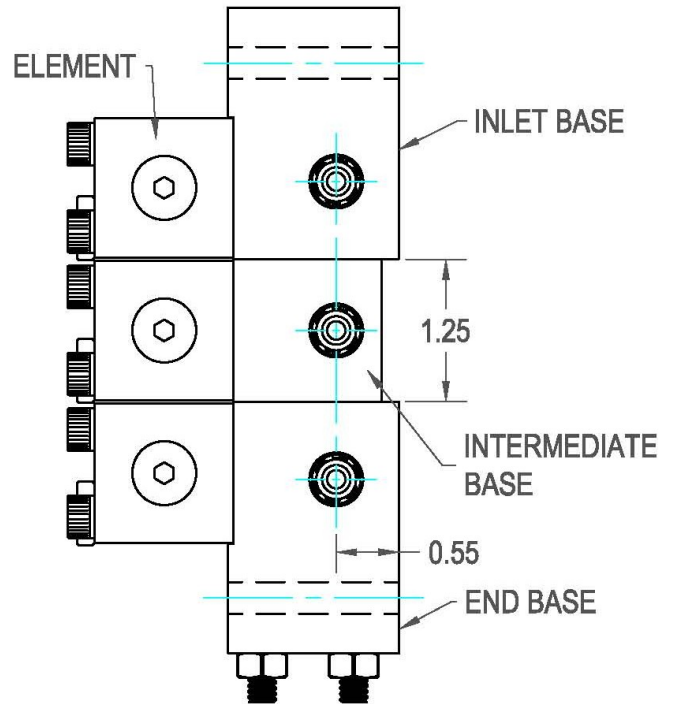
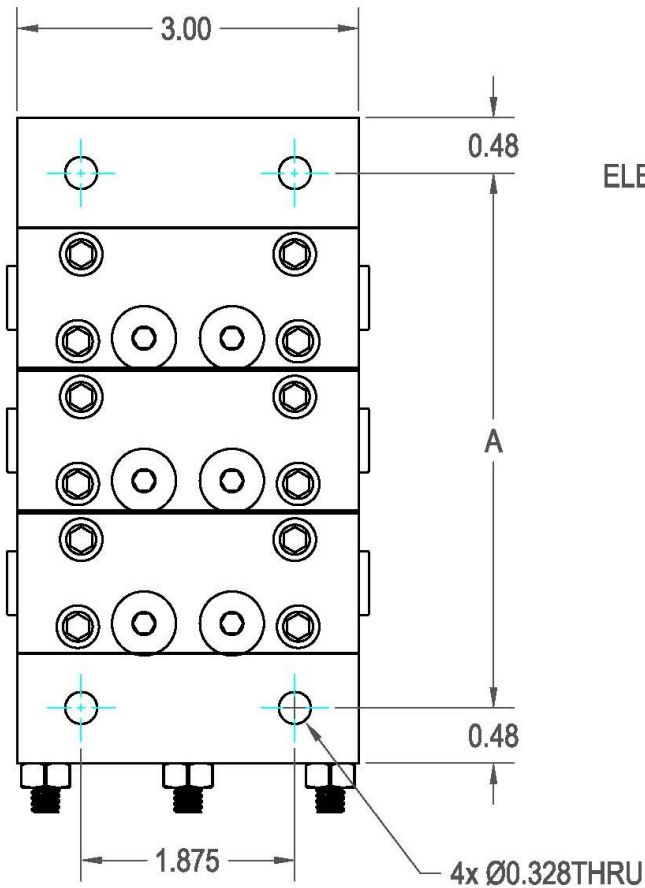

- The XD inlet and end have 1/4" NPT ports.
- Intermediates have a custom 1/8-27 NPSF ORB (o-ring boss) port.
- CPI custom 1/8-27 NPSF ORB fittings are recommend for optimal sealing and ease of use. 1/8 NPT fittings can also be used, however this permanently changes the thread profile preventing the future use of the 1/8-27 NPSF ORB fittings.
- Elements use the Trabon style magnet housing port.
- Elements have custom 1/8-27 NPSF ORB ports for the pin indicators.

6.4 HP Divider Block Dimensions

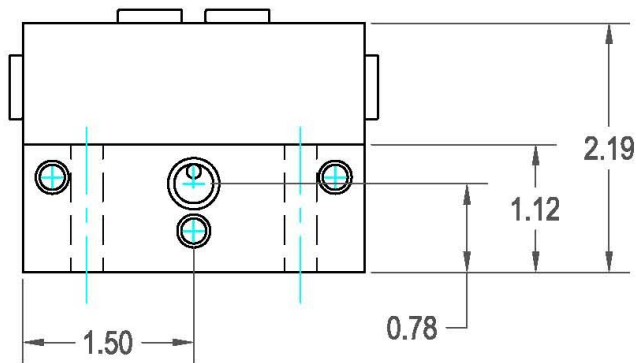

HP Sections	A ± 0.010" [0.254mm]
3	3.375" [85.72mm]
4	4.300" [109.22mm]
5	5.225" [132.72mm]
6	6.150" [156.21mm]
7	7.075" [179.71mm]

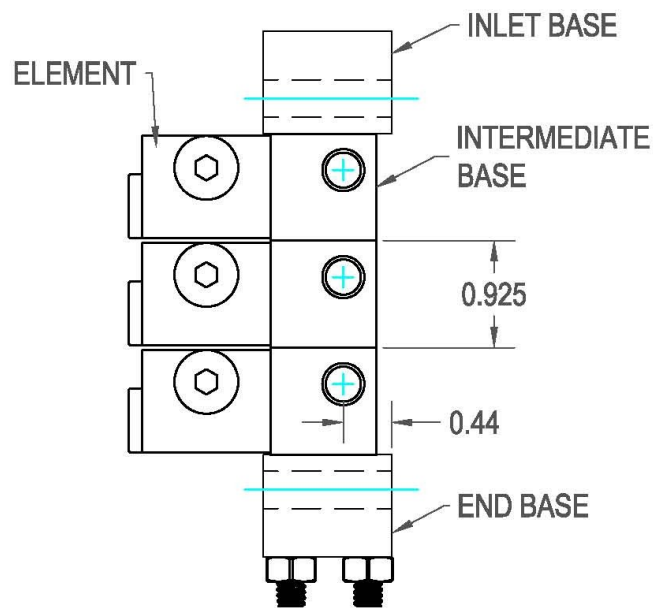
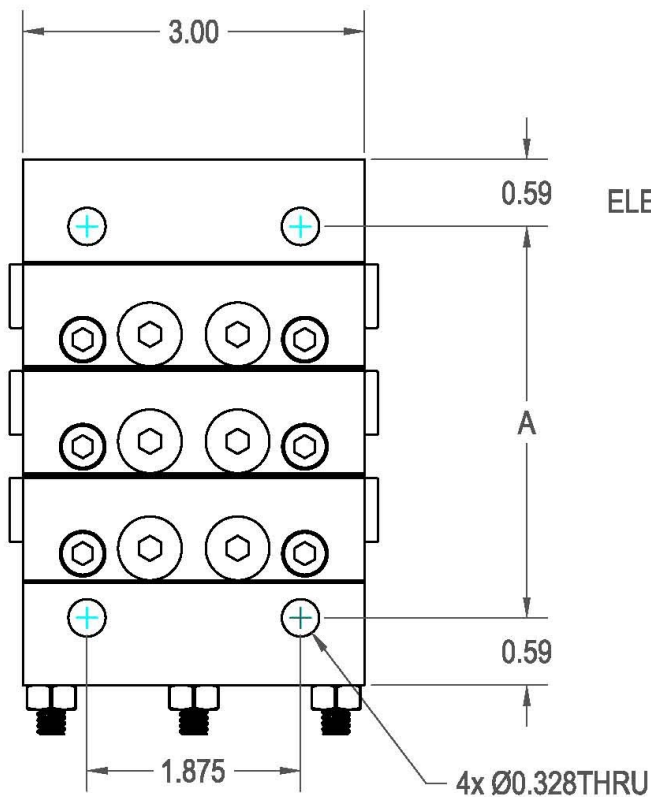

- The HP inlet and end have a custom 1/8-27 NPSF ORB (o-ring boss) port.
- Intermediates have a custom 1/8-27 NPSF ORB (o-ring boss) port.
- CPI custom 1/8-27 NPSF ORB fittings are recommend for optimal sealing and ease of use. 1/8 NPT fittings can also be used, however this permanently changes the thread profile preventing the future use of the 1/8-27 NPSF ORB fittings.
- Elements use the Trabon style magnet housing port.
- Elements have custom 1/8-27 NPSF ORB ports for the pin indicators.

7. Troubleshooting

Problem	Cause	Solution
Leaking Tubing Connections or	Loose fittings	Tighten all tube fittings. If necessary replace tubing fittings and tubing.
	Damaged tubing	Replace all leaking tubing.
Excessively High Pressure On Pressure Gauge, Atmospheric Rupture Disc Is Not Blown	Atmospheric assembly	Check for plugged rupture assembly, wrong color rupture disc in assembly or more than one disc in rupture assembly. Never Block or Plug the Atmospheric Rupture Assembly.
	Incorrect torque of divider blocks (Too tight)	Divider blocks are fitted to extremely close tolerances. Over tightening will cause excessive system pressure. Loosen Allen head screws and re-torque to 108 Inch lbs. Max.
	Oil Separation	Wax or soap like deposits indicate separation of lubricant additives. Clean all lube system components. When oil separation is present cleaning will only temporarily solve this problem.
Erratic Movement or Wide Swing of Needle on Pressure Gauge	Air or gas in lube system	Purge all tubing lines and divider blocks.
	Leaking check valves	Check temperature of each check valve. Check valves with higher temperatures indicate leakage. Loosen tubing connections at inlet of check valves. Foaming oil indicates leaking check valve. Replace All Leaking Check Valves Immediately.
	By-Passing divider blocks	Pressure test all divider blocks for by-passing. Replace all divider blocks that do not hold pressure. DO NOT use emery cloth, bearing cloth or any type of abrasive substance to smooth piston or bore of divider blocks.
	High differential pressure between injection points	If there is more than 1000PSI difference between low pressure injection points and high pressure injection points the system should be balanced to within 400PSI.
	Incorrect torque of divider blocks	Divider blocks are fitted to extremely close tolerances. Over tightening will cause excessive system pressure. Loosen Allen head screws and re-torque to 108 Inch lbs. Max.
Cycle Time of Divider Block Slows Down or Becomes Erratic	Air or gas in lube system	Purge all tubing lines and divider blocks
	Defective lubricator pump	See lube pump operation manual for trouble shooting guide.
	Low oil supply from lubricator pump	See lube pump operation manual for trouble shooting guide.
Compressor Continually Shuts Down on Lube No-Flow Rupture Disc is Not Blown	Check DNFT for correct operation	See no-flow device manual for trouble shooting guide.
	Defective or worn lubricator pump	See lube pump operation manual for trouble shooting guide.
	Dirt/Debris in lubricator pump	See lube pump operation manual for trouble shooting guide.
	No oil supply to pump	See lube pump operation manual for trouble shooting guide.
	Air or gas in system	Purge all tubing lines and divider blocks.
	Filter blocked	Check all in line filters for blockage and replace as necessary. All filters in the lubrication system should be changed a minimum of every three (3) to six (6) months depending on the application of the divider block system and environment.
	Faulty wiring	See no-flow device manual for trouble shooting guide.

Problem	Cause	Solution
Atmospheric Rupture Disc is Blown. Compressor is Down	Air or gas in lube system	Purge all tubing lines and divider blocks.
	Nut on atmospheric rupture assembly over tightened	Install new rupture disc and hand tighten nut on rupture assembly. If torque wrench is available torque nut to 36 inch pounds max. If torque wrench is not available hand tighten and tighten with end wrench 1/16th turn. Do not over tighten nut. Over tightening nut on rupture assembly cuts into aluminum rupture disc causing disc to blow out at lower pressures.
	Crushed tubing	Make a visual inspection of the system and check for crushed tubing lines. Correct as needed
	Defective tubing fitting	Use purge gun to pump oil through tubing lines to locate blockage. Correct as needed
	Blocked injection point	Use purge gun to pump oil into injection points. Oil should flow freely into each injection point. Correct as needed.
	Blocked check valve	Use purge gun to pump oil through each check valve. Oil should flow easily through check valves with less than 160 psi. If plugged replace check valve
	Pipe plug improperly installed in baseplate	Check to ensure all divider blocks required to discharge oil do not have pipe plugs installed in an outlet designed to disperse oil to an injection point. Divider blocks with a letter "T" stamped on the front should have (2) two outlets open from the base plate. Divider blocks with a letter "S" stamped on the front should have (1) one outlet open on the base plate and one outlet plugged.
	Dirt/Debris in divider valve block	Use purge gun to locate blockage.
	Wrong magnet assembly for proximity switch	Each divider valve manufacturer uses a different magnet assembly. Check for correct magnet assembly installed on divider valve. Correct as needed.
	Divider block assembly is out of sync	If new divider blocks are installed there is a possibility the pistons are out of sync in the hydraulic circuit. To correct this problem remove end plugs from one side of each divider block in the assembly. Using a brass rod push each piston to the opposite end of the divider block. Replace end plugs and purge the divider block assembly to check for correct operation.
Oil separation	Wax or soap like deposits indicate separation of lubricant additives. Clean all lube system components. When oil separation is present cleaning will only temporarily solve this problem.	
Atmospheric Rupture Disc is Blown. Compressor Does Not Shut Down.	No-Flow is disconnected	Check wiring connections to no-flow and inside of control panel. Correct as needed. Never Continue to operate the Compressor With the No-Flow Disabled or Disconnected
	Defective No-Flow	See no-flow device manual for trouble shooting guide.
	DNFT or Proflo Jr. is connected to control panel or alarm incorrectly	See no-flow device manual for trouble shooting guide.
	Adjust DNFT or Proflo Jr.	See no-flow device manual for trouble shooting guide.

7.1 Locating Blockage in Divider Block Lubrication Systems

Make a visual inspection of the system and check for crushed tubing lines. Check to ensure all divider blocks required to discharge oil do not have pipe plugs installed in the base plate outlet. Divider blocks with a letter “T” on the front should have (2) two outlets open from the base plate. Divider blocks with a letter “S” on the front should have (1) one outlet open on the base plate and one outlet plugged.

Test processes:

A. Divider Block Systems with One Divider Valve Assembly and Reset Pressure Indicator Pins:

Connect a manual lubrication system purge gun to the inlet of the divider block assembly or purge port on the pressure cross assembly as shown in (fig. 3) and slowly operate pump. Continue to raise pressure until an indicator pin pops out, see (fig. 4). If no indicator pin pops out, blockage is in the divider block assembly, see **Step D4**. If an indicator pin pops out, the extended pin indicates blockage down the discharge line common to that pin. Remove the tubing connection from the check valve at the injection point common to the divider block with the indicator pin extended out. Slowly operate the purge pump. If high pressure exists check tubing and fittings. If the purge pump operates freely and oil flows from the tubing, connect the purge pump to the check valve at the injection point. Slowly operate the purge pump. If high pressure exists the check valve or the injection point on the cylinder or packing gland is plugged. Correct as necessary. Always test the check valve for reverse leakage by pumping oil into the outlet side. If oil leaks through the check valve replace it immediately.

B. Divider Block Systems with One Divider Valve Assembly without Reset Pressure Indicator Pins:

With manual purge gun connected to the divider block or purge port on the pressure cross assembly as in the previous step, remove each indicator port plug one at a time and slowly operate the pump. Do not exceed 1,000 PSI. If pressure on the gauge holds replace the indicator port plug. Remove and replace each indicator port plug one at a time until pressure drops on the pressure gauge and the

divider block cycles freely when operating the purge pump. If the pressure gauge drops after removing an indicator port plug and the divider valve cycles freely the blockage is downstream of that individual divider block.

Replace the indicator port plug and remove the tubing connection from the check valve at the injection point. Slowly operate the purge pump. If high pressure exists check tubing and fittings. If the purge pump operates freely and oil flows from the tubing connect the purge pump to the check valve at the injection point. Slowly operate the purge pump. If high pressure exists the check valve or the injection point on the cylinder or packing gland is plugged. Correct as necessary. Always test the check valve for reverse leakage by pumping oil into the outlet side of the check valve. If oil leaks through the check valve replace it immediately. If all indicator port plugs are removed and the divider block will not cycle, blockage is in the divider block assembly, see **Step D4**.

C. Divider Block Systems with Master and Secondary Divider Blocks with Pressure Indicator Pins installed:

Connect a manual lubrication system purge gun as shown in (fig. 3) to the inlet of the master divider block assembly or purge port on the pressure cross assembly and slowly operate pump. Continue to raise pressure until an indicator pin pops out, see (fig. 4). The pin indicates blockage down the discharge line common to that pin. If an indicator pin pops out, see **Step D2**. If no indicator pin pops out, blockage is in the master divider block assembly, see **Step D4**.

D. Divider Blocks Without Pressure Indicator Pins:

1. **Step D1:** With manual purge gun connected to the master divider block or purge port on the pressure cross assembly remove each indicator port plug one at a time and operate the pump. Do not exceed 1,000 PSI. If pressure on the gauge drops and the divider block cycles freely after an indicator plug is removed, the blockage is downstream of that individual divider block, see **Step D2**. If all

indicator port plugs are removed and the master divider block will not cycle, blockage is in this divider block assembly, see **Step D4**.

2. **Step D2:** Testing indicates blockage is located downstream of the Master divider block. If installed remove the indicator pin or indicator port plug and connect the purge gun to the indicator port on the front of the master divider block that feeds the blocked line. See (fig. 6). Remove all indicator port plugs in the secondary divider block assembly. If oil can be easily pumped through all indicator ports, the blockage is not in the tubing line or the divider valve, see **Step D3**. If oil does not flow freely through the indicator ports the blockage is in the secondary divider block or its supply line. Disconnect the tubing line from the inlet of the secondary divider block assembly and pump the purge gun to verify blockage is not in the tubing line. If blockage is in the divider block assembly, see **Step D4**.
3. **Step D3:** Remove indicator port plugs or indicator pins from the secondary divider blocks. Connect purge gun to each indicator port of the secondary divider blocks one at a time and slowly operate pump as shown in (fig. 7). If high pressure exists in any port tested blockage has been located. Check tube, fittings, check valves, packing gland and cylinder injection points by pumping oil into each.
4. **Step D4:** When testing indicates blockage is in the divider block, before disassembly, remove all piston enclosure plugs, see (fig. 8). Without removing the pistons use a brass rod and finger pressure only to move each piston back and forth. If all pistons are moveable, replace the enclosure plugs and retest the assembly by pumping oil into the inlet. (Blockage may have been dislodged and the assembly may be in working condition without further service.) If piston is jammed or wax like substance or dirt is found in the piston bore, the divider block must be disassembled and cleaned. Before removing, make a note of divider block positions on the base from top to bottom, see (fig. 3). (Example 9T-12T-24T). Working with one block at a time, remove the piston with a

brass rod. If the piston is stuck, try removing it in the opposite direction. The piston may have to be forced out by lightly tapping it with a brass rod only. Do not use any type of hard metal object to remove the piston. After removal, thoroughly wash the piston and divider block with a clean suitable solvent. Blow out all ports in the divider block and use a small piece of wire to clean out all passages. Inspect divider block bore and piston for scratches or score marks. If either of these are damaged a new divider block must be installed. The final step is to thoroughly clean the base sections and blow out all ports with compressed air.

Caution: DO NOT use emery cloth, bearing cloth or any type of abrasive substance to clean or smooth any piston or bore. To do so will cause the divider block to bypass and can cause extensive damage to compressor components. Pistons are precision fitted to each bore to extremely close tolerances and cannot be turned end for end or interchanged with other pistons.

After entire divider block assembly has been cleaned, inspected and all blocks and pistons appear in good condition, lubricate and reassemble, positioning the divider blocks on the base in their original order as per notes. Make sure all pistons slide smoothly and fit snugly in divider block bores. After assembly, test for proper operation and purge the system with a purge gun using oil common to the system. To insure proper operation of the divider block system, it is absolutely necessary that all tubing and components be filled with clean oil common to the system. All air must be purged from tubing and components before start-up. See Section 5.1 "Purging Air From the System" for instruction.

Locating Blockage in Divider Block lubrication systems

Figure 3 Lubrication System with One Divider Block Assembly

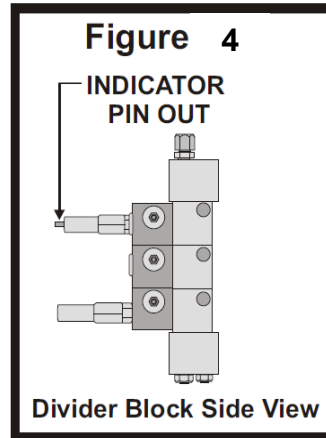
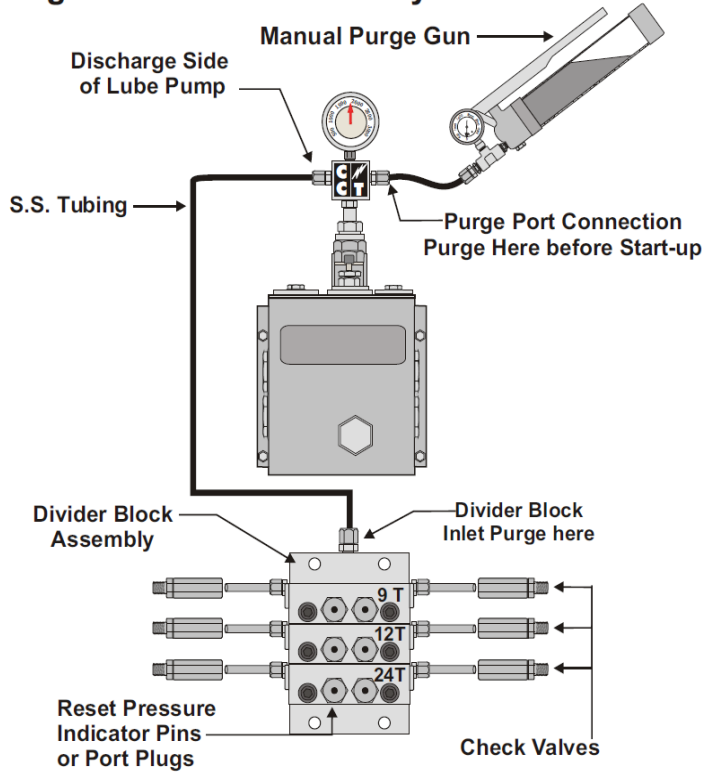
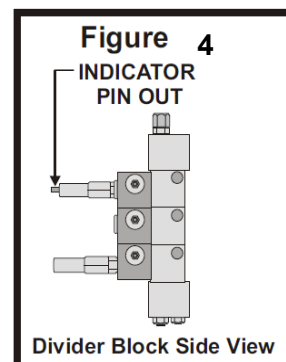
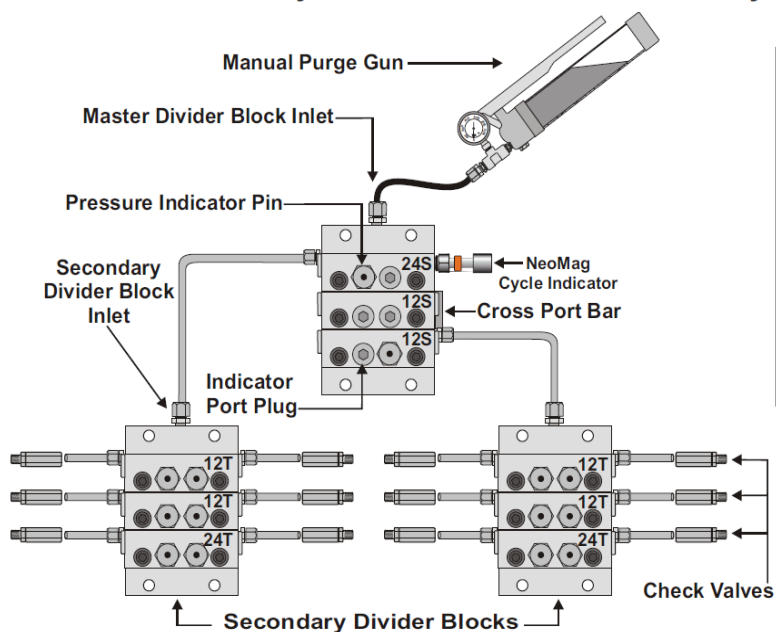
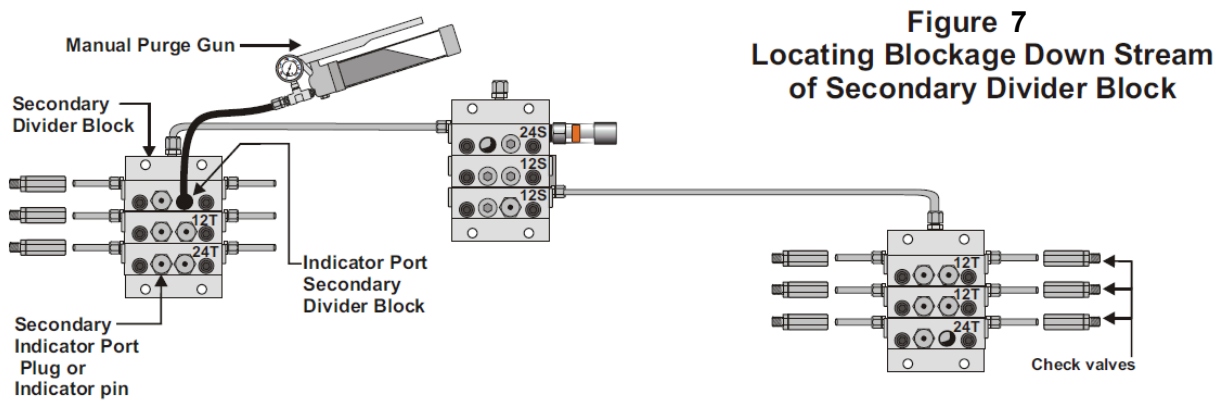
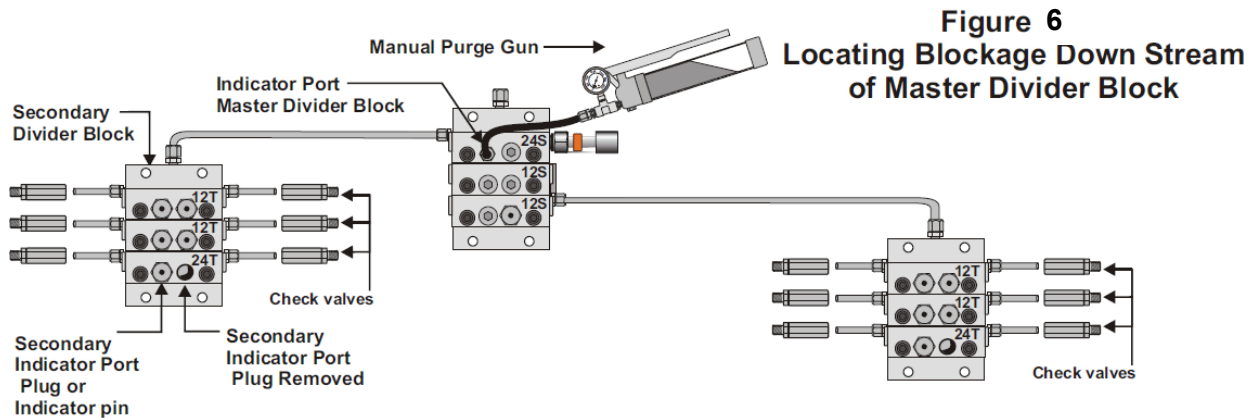

Figure 5 Lubrication System with Master and Secondary Divider Blocks





7.2 Pressure Testing Divider Blocks for By-Passing

All divider blocks are metal to metal sealing surfaces and the possibility of oil passing around the piston to a point of least resistance is always present. By-passing can be a result of excessive clearance between the piston and bore of a new divider block or from millions of cycles each year causing wear between the piston and bore. For this reason it is necessary to test each individual divider block before installation and/or after continued use. This will confirm the piston to bore tolerances are close enough to build adequate pressure to force oil into the injection point. Note: Never assume tolerances between the piston and bore are acceptable even if the divider block is new and the piston is cycling properly. Pressure test all divider blocks in low to medium service at least every two years.

Procedure for Testing Divider Blocks For By-Passing

To test divider blocks for by-passing, a manual purge gun equipped with a pressure gauge and capable of developing 5000 PSI is necessary. For pressure testing the divider block use a 10-weight oil at room temperature to simulate hot oil. Test each divider block assembly complete with pin indicators installed. Test only one divider block at a time.

Place the divider block assembly in an open container with all base outlets open. Connect the purge gun to the inlet of the divider block assembly. Operate the purge gun to cycle the divider block several times to purge air from the assembly and verify that oil will flow freely from all outlets. Divider blocks should cycle at less than 300 PSI. (See fig. 8).

Divider blocks marked with a "T" should have only one outlet on the base plugged during testing of that

side of the piston. Each outlet of the divider block marked with a "T" must be plugged and tested one side at a time (See fig. 9).

Individual testing of each outlet ensures both sides of the piston will build adequate pressure. All divider blocks marked with an "S" on the front should have both outlets on the base plugged to test for by-passing (See fig. 10). This will test both sides of the piston at the same time.

Plug the outlet on the base under the divider block being tested with a 1/8" pipe plug. If a tubing fitting is installed in the base, plug the fitting with a tubing plug. Leave all other outlets open. Operate the purge gun until the pressure gauge indicates 3000 PSI. The block may cycle once or twice, but should pressure to 3500 PSI immediately. Stop pumping oil into the divider valve at 3500 PSI. Check the plug in the discharge outlet to confirm there are no external leaks. The pressure gauge should not lose more than 1000 PSI during a 30-second test. **Note: Testing the divider blocks at higher pressures is necessary if the application dictates higher system operation.**

If the pressure gauge on the purge gun drops suddenly and oil squirts from the other outlets, a by-pass condition exists. The piston is worn and is allowing oil to by-pass. This is not acceptable and the divider block must be replaced. If the tested block does not lose more than 1000 PSI in 30 seconds, relieve the pressure, move the plug to the next outlet and repeat the same test. After all divider blocks have been pressure tested with this recommended procedure, the divider blocks should be reassembled, purged with oil and put back in service.

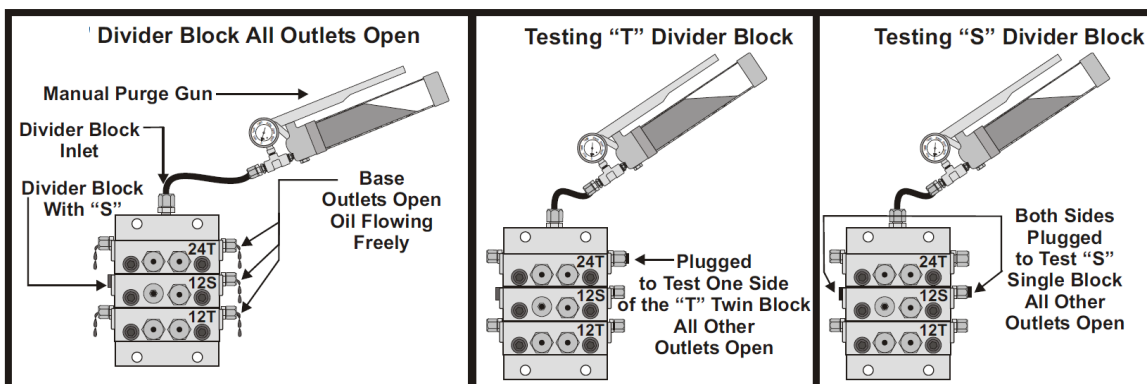

Fig. 8

Fig. 9

Fig. 10

Prepared By:



4410 Greenbriar Drive ▪ Stafford, Texas 77477 USA

Tel 281.207.4600 ▪ Fax 281.207.4612

Website: www.c-p-i.com